

# Data Sheet



Article number: 02140000023

Description: Sealing Clamp S 23 W1

## Measures

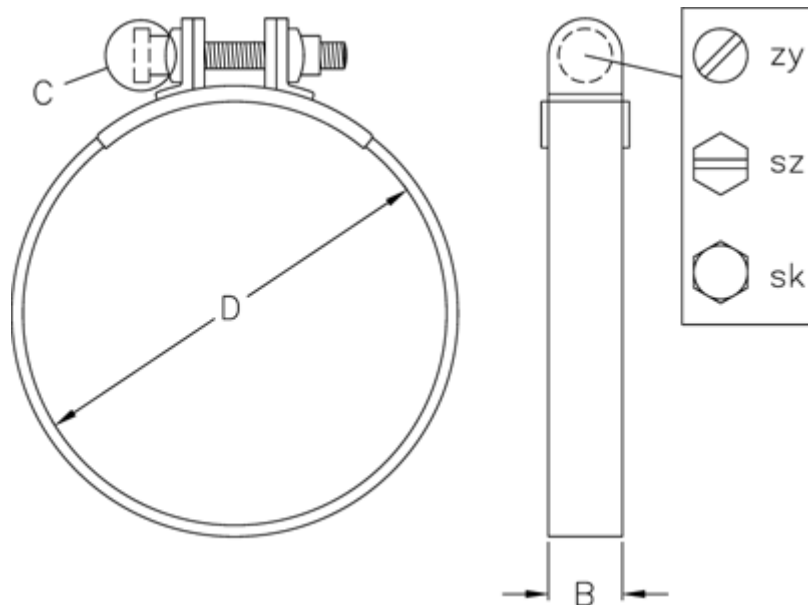

C (screw type) = SZ

Diameter D = 23

Width B = 15